

# MEDIUM VELOCITY WATER SPRAY NOZZLE

## TECHNICAL DATA

MODEL	MV-A & MV-AS Brass Material MV-B & MV-BS Stainless Steel Material MV-E Aluminium Bronze Material	
TYPE	MV-A, MV-B & MV-E are without strainer MV-AS & MV-BS are with strainer	
MAXIMUM WORKING PRESSURE	12 Bar (175 PSI)	
END CONNECTION	1/2" BSPT (1/2" NPT OPTIONAL)	
MATERIAL	Refer Table-I	
INCLUDED WATER SPRAY ANGLE FOR EACH K-FACTOR	160°, 140°, 120°, 110°, 100°, 90°, 80° & 65°	
K FACTOR	MV-A/MV-B & MV-E Metric (US) K-18 (1.26) K-22 (1.54) K-26 (1.8) K-30 (2.10) K-35 (2.45) K-41 (2.87) K-51 (3.57) K-64 (4.48) K-79 (5.53) K-91 (6.37) K-102 (7.14)	MV-AS/MV-BS Metric (US) K-18 (1.26) K-22 (1.54) K-26 (1.8) K-30 (2.10) K-35 (2.45) K-41 (2.87)
FINISH	MV-A & MV-AS Natural Brass finish, Nickel-Chrome plated, Electroless Nickel plated, Epoxy powder coated. MV-B, MV-BS & MV-E Natural finish	
APPROVALS	UL Listed, FM Approved & LRS-Lloyd's Register Approved Blow-off Plug- FM Approved For Approval data refer Table-II	
ORDERING INFORMATION	Specify K-Factor, spray angle, finish, model and end connection	



## DESCRIPTION

The HD® Medium Velocity Water Spray Nozzles are open type (non-automatic) nozzles, designed for directional spray application in fixed fire protection system.

Medium velocity water spray nozzle has an external deflector, which discharges water in a directional cone shaped pattern of small droplet size. The water is uniformly distributed over the surface to be protected.

MV Nozzles are effectively designed to apply water to exposed vertical, horizontal, curved and irregular shaped surfaces to allow cooling to prevent excessive absorption of heat from external fire and avoid structural damage or spread of fire. In some application nozzles may be installed to control or extinguish the fire depending on water design density as per applicable codes. The nozzle is used in deluge water spray system for special hazard fire protection application.

As the design and intent of specific water spray system may vary considerably, MV nozzle is made available in several combinations of orifice sizes (K-factors) and spray angles.

The minimum desirable pressure to achieve a reasonable spray pattern is 1.4 Kg./Sq.cm. The water distribution pattern as shown in the graph in following pages is at an average pressure of 2.0 Kg/Sq.cm. The change in pressure between 1.4 to 3.5 Kg./sq.cm. does not affect considerable change in spray angle.

The spray pattern shown is with indoor application. System designer must consider wind velocity while designing the system for outdoor application. Field obstruction if any affecting the spray pattern of the nozzle must also be considered. The nozzle may be oriented to any position as deemed necessary to cover the hazard.

# MEDIUM VELOCITY WATER SPRAY NOZZLE

The Blow-off plugs can be used to prevent the depositing of foreign materials in the water way of the nozzles, which could interfere with discharge of the spray nozzle. Blow-off plugs are optional and are FM Approved. Blow-off Plugs have identification mark with respect to K factor. For example, Blow off plug for nozzle having K-factor 22 will have identification mark of 22. Minimum operating pressure for nozzle having Blow-off plug is 1.4 Kg./Sq.cm (20 PSI).

The main pipeline strainer as per NFPA-15 is required for system utilizing nozzle orifice diameter less than 9.5mm (3/8 inch), i.e.MV Nozzle having K-factor 41 and less, and also for the system water likely to contain obstructive materials.

## INSTALLATION & MAINTENANCE

The spray nozzle must be handled with due care. For best results, the storage as well as any further shipment shall be made in original packing only.

Nozzle which is visibly damaged should not be installed. Use Teflon tape or soft thread sealant on male thread of the nozzle.

The nozzles must be hand tightened into the fitting. After hand tightening use Nozzle Wrench-NW-M for wrench tightening in to nozzle fittings. Excessive tightening torque may result into serious damage to nozzle arms and the deflector, which may affect spray pattern of the nozzle and its performance.

It is recommended that water spray system be inspected regularly by authorised technical personnel.

The nozzle must be checked for atmospheric effects, external and internal obstruction, blockage if any. The system must be operated with optimum water flow at least twice in a year or as per the provisions of NFPA or local authority having jurisdiction.

It is recommended to design water spray system as per guidelines of NFPA15 and/or AHJ.

The owner is solely responsible for maintaining the water spray system and the components there in so that it performs properly when required.

MODEL MV-A, MV-B & MV-E

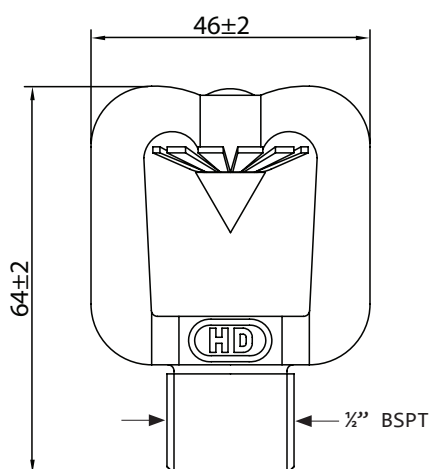

MODEL MV-AS, & MV-BS

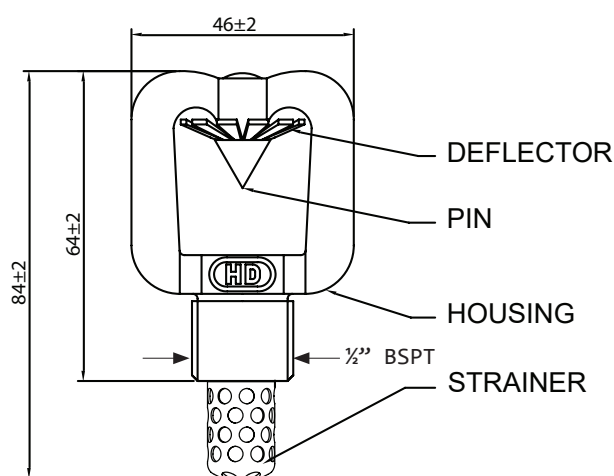

Nozzles with Blow-off Plug

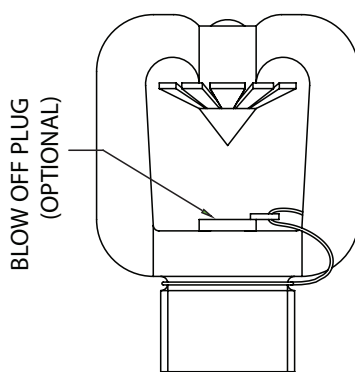

# MEDIUM VELOCITY WATER SPRAY NOZZLE

TABLE - I : MATERIAL OF CONSTRUCTION

COMPONENT	MODEL MV-A & MV-AS	MODEL MV-B & MV-BS		MODEL MV-E
		STANDARD	OPTIONAL	
HOUSING	BRASS, IS:291 GR.-1 (EQUIVALENT TO ASTM B21)	ASTM A351-CF8M (STAINLESS STEEL 316)	ASTM A351 CF3M (STAINLESS STEEL 316L)	ALUMINIUM BRONZE IS:305-AB1 (EQUIVALENT TO ASTM B148)
PIN	BRASS IS:291. GR. -1 (EQUIVALENT TO ASTM B21)	ASTM-A479 GR 31803	ASTM A479 TYP. 316L	PH.BRONZE IS:7811 (EQUIVALENT TO ASTM B139)
DEFLECTOR	BRASS IS:2768 (EQUIVALENT TO ASTM B36)	ASTM A240 GR 2205	ASTM A240 TYP. 316L	PH.BRONZE IS:7814-GR-II (EQUIVALENT TO ASTM B103)
STRAINER	COPPER (FOR MV-AS)	STAINLESS STEEL 316 (FOR MV-BS)	STAINLESS STEEL 316L	-
BLOW-OFF CAP	ELASTOMER	ELASTOMER	ELASTOMER	ELASTOMER

Note: Equivalent specification is indicative only.

TABLE - II : APPROVAL DATA

K-FACTOR	SPRAY ANGLE	MODEL & APPROVALS														
		MV-A BRASS, WITHOUT STRAINER			MV-AS BRASS, WITH STRAINER			MV-B STAINLESS STEEL WITHOUT STRAINER			MV-BS STAINLESS STEEL WITH STRAINER			MV-E ALUMINIUM BRONZE		
		UL	FM	LRS	UL	FM	LRS	UL	FM	LRS	UL	FM	LRS	UL	FM	LRS
K- 18, 22, 30, 35, 41	65°, 80°, 90°, 100°, 110°, 120°, 140°	√	√	√	√	√	√	√	√	√	√	√	√	√	√	√
K- 18, 22, 30, 35, 41	160°	√	--	--	√	--	--	√	--	--	√	--	--	√	--	--
K- 26	65°, 80°, 90°, 100°, 110°, 120°, 140°, 160°	√	--	--	√	--	--	√	--	--	√	--	--	√	--	--
K- 51, 64, 79, 91, 102	65°, 80°, 90°, 100°, 110°, 120°, 140°	√	√	√	--	--	--	√	√	√	--	--	--	√	√	√

# MEDIUM VELOCITY WATER SPRAY NOZZLE

## DISCHARGE CHARACTERISTICS

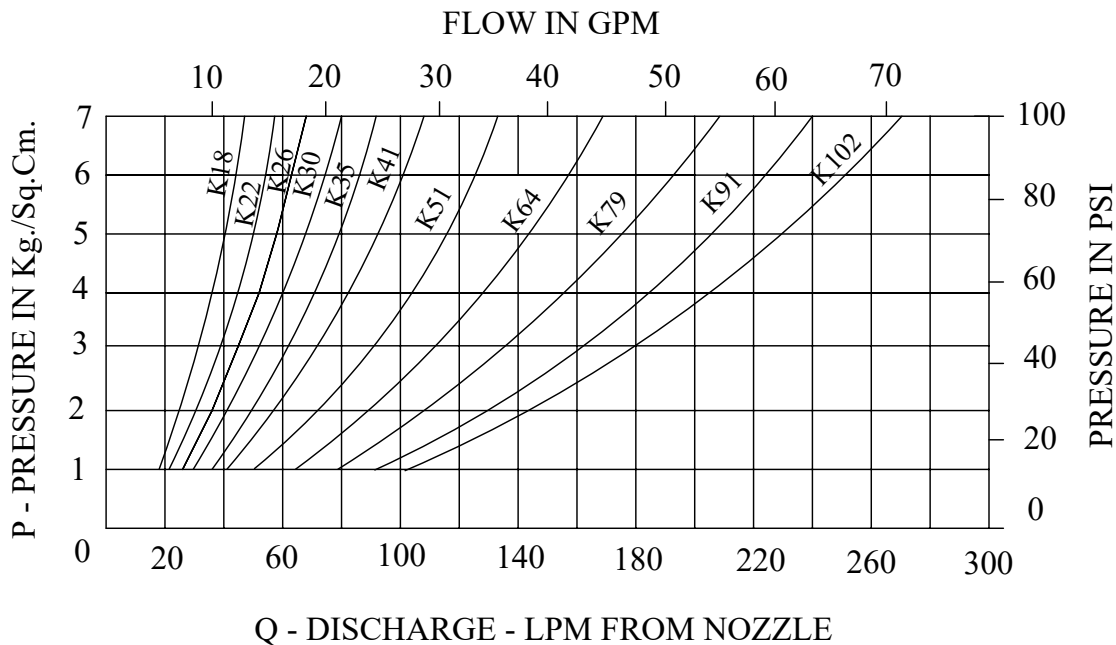

$Q = K \sqrt{P}$  where P is supply pressure in Kg/sq.cm., K= nozzle constant (K-factor) in metric  
US K factor = Metric K factor MK ÷ 14.2745

## SPRAY PATTERN

SPRAY ANGLE 65°

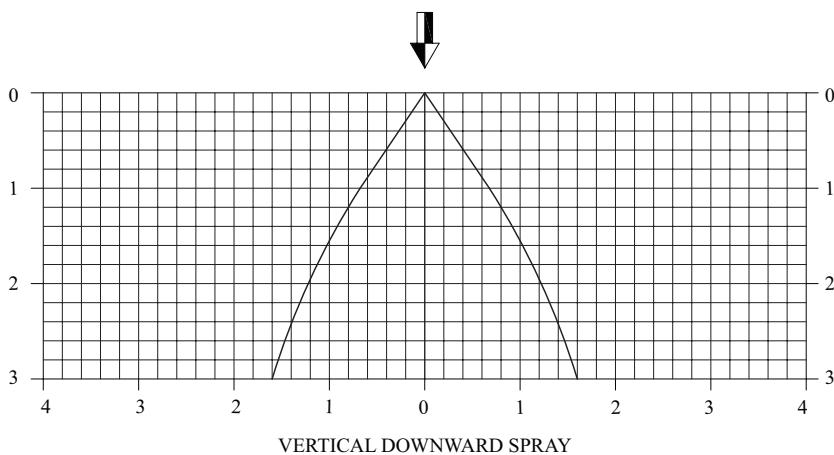
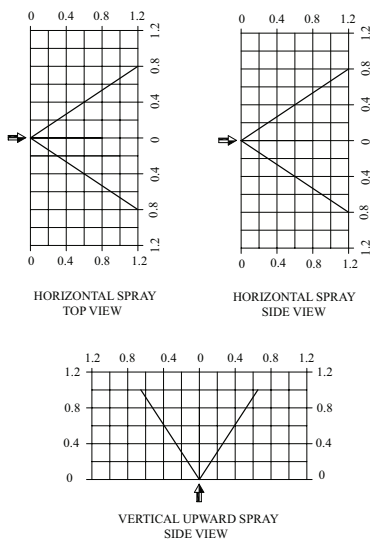

ALL DIMENSIONS ARE IN METERS

# MEDIUM VELOCITY WATER SPRAY NOZZLE

## SPRAY PATTERN

### SPRAY ANGLE 80°

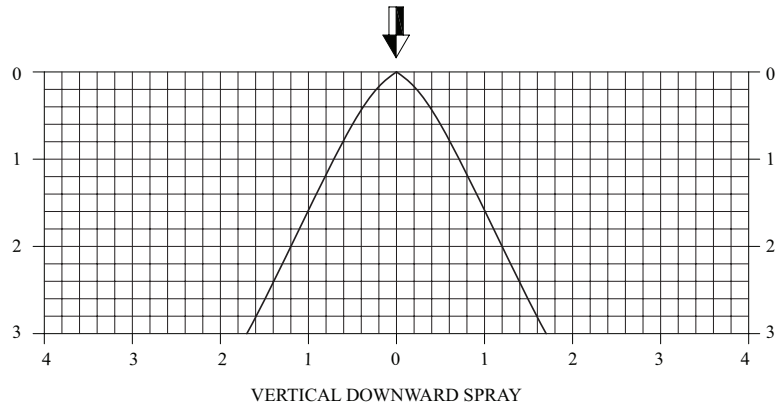
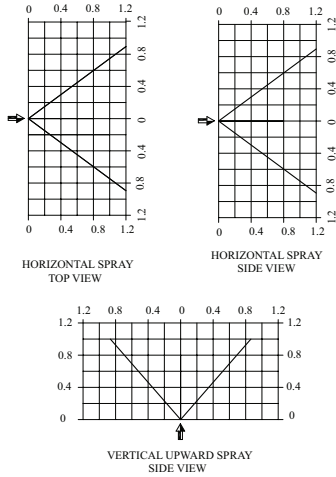

### SPRAY ANGLE 90°

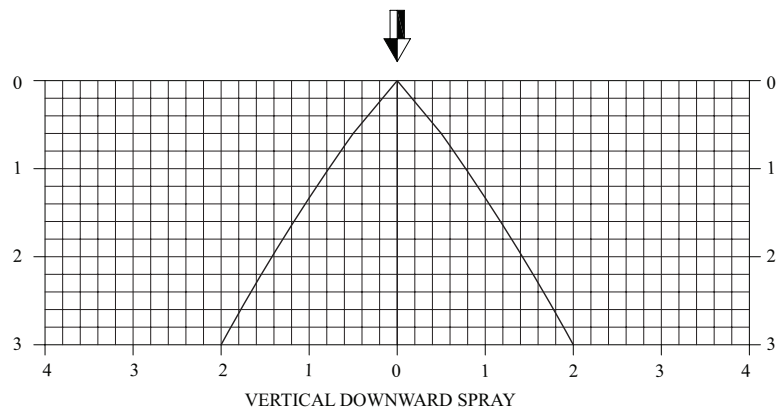
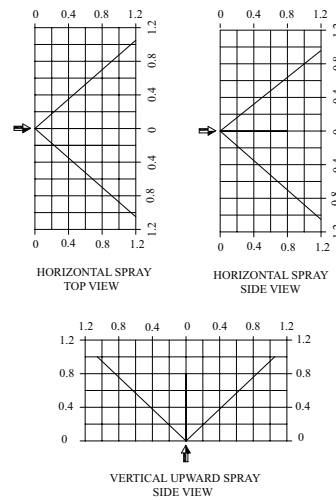

### SPRAY ANGLE 100°

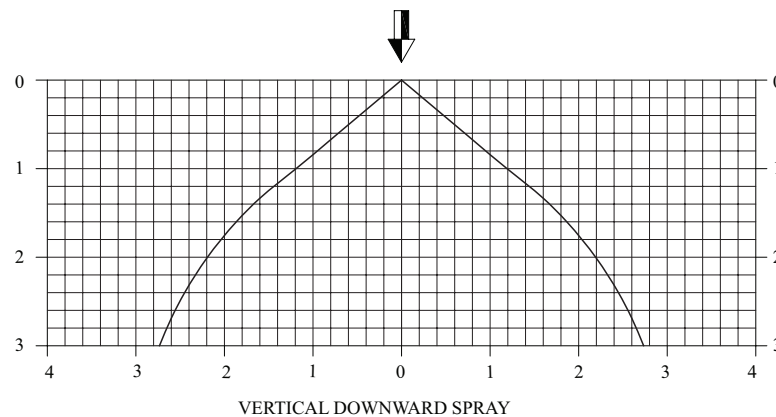
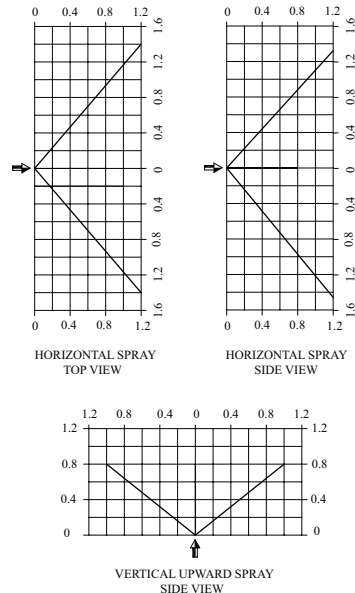

ALL DIMENSIONS ARE IN METERS

# MEDIUM VELOCITY WATER SPRAY NOZZLE

## SPRAY PATTERN

### SPRAY ANGLE 110°

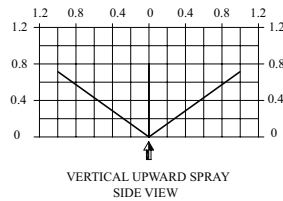
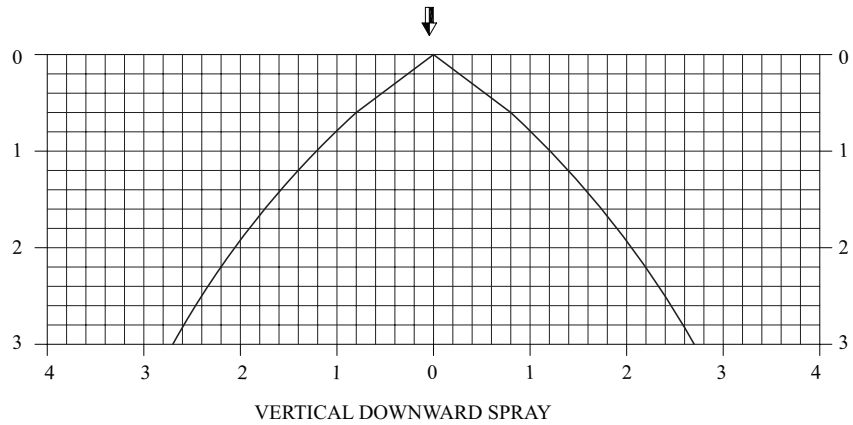
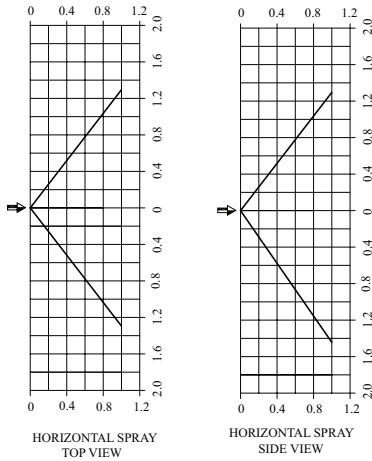

### SPRAY ANGLE 120°

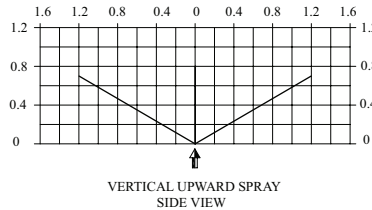
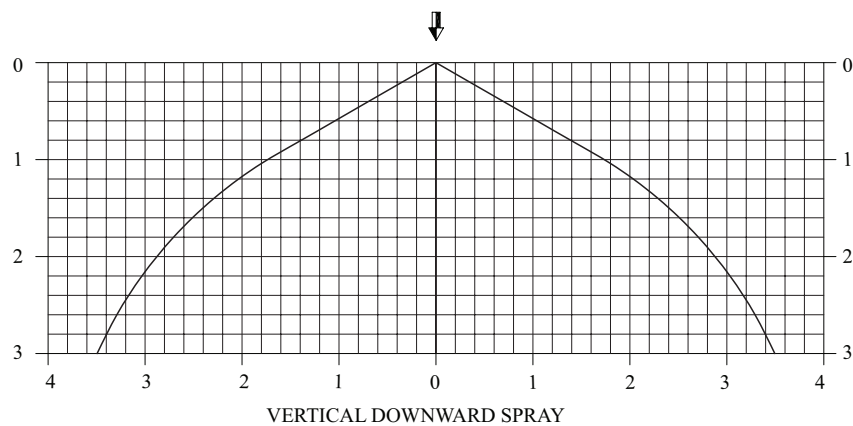
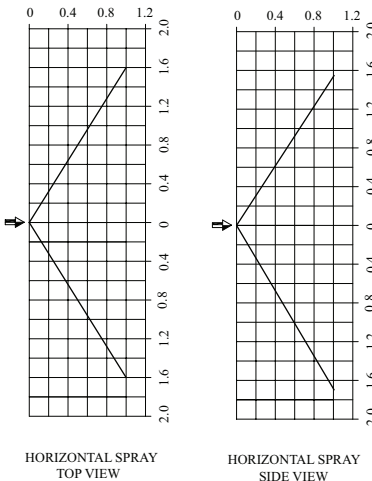

ALL DIMENSIONS ARE IN METERS

# MEDIUM VELOCITY WATER SPRAY NOZZLE

## SPRAY PATTERN

### SPRAY ANGLE 140°

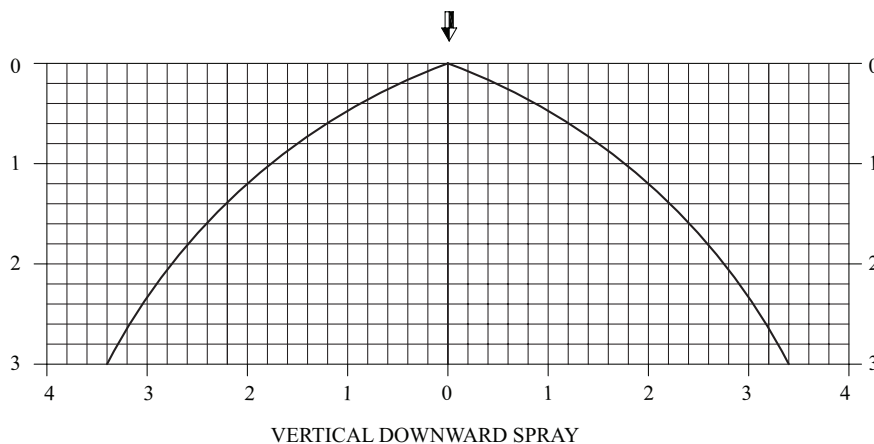
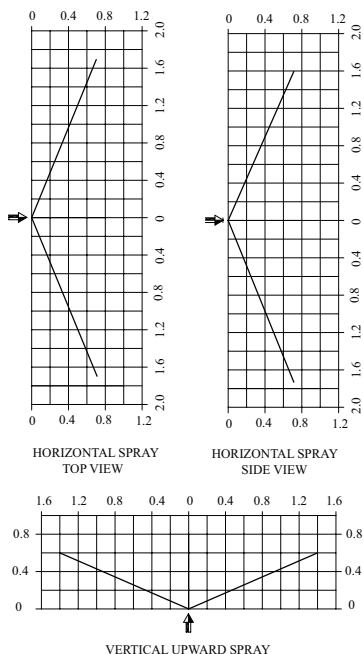

### SPRAY ANGLE 160°

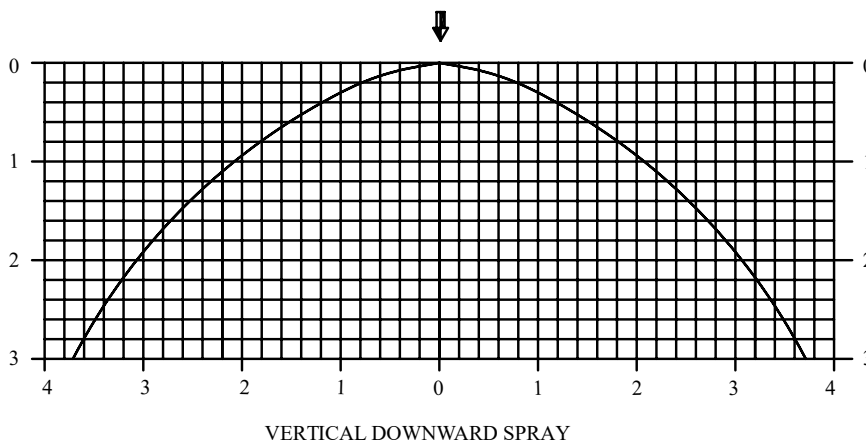
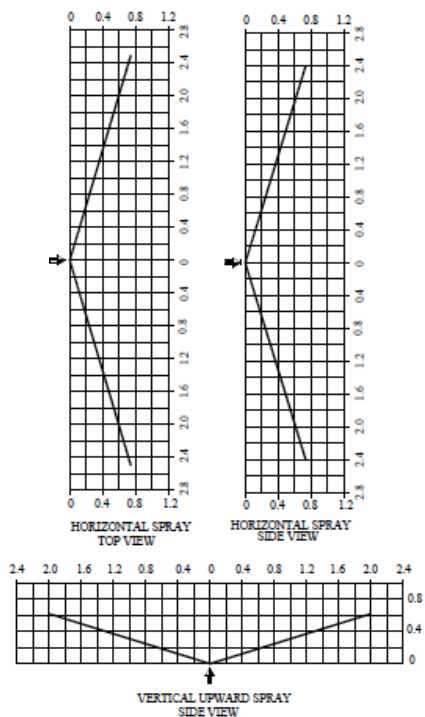

ALL DIMENSIONS ARE IN METERS

Note :

- 1) The design spray patterns given in graphs are included spray angle of 65 Deg. to 160 Deg. at nozzle inlet pressure of 1.4 to 4.1 Bar. When the nozzle pressure above 4.1 Bar is applied, the coverage area will decrease because the spray pattern tends to draw inward at higher pressure. Consult HD Technical Services for pressure upto 12.1 Bar.
- 2) The spray data are obtained from the test in still air.

# MEDIUM VELOCITY WATER SPRAY NOZZLE

MV NOZZLE WRENCH MODEL NW-M

